

Poseidon2 3268

MANUAL



Safety information

The device complies with regulations and industrial standards in force in the Czech Republic and the European Union. The device has been tested and is supplied in working order. To keep the device in this condition, it is necessary to adhere to the following safety and maintenance instructions.

Never remove the device cover if the relay terminals are connected to the electrical network!

Using the device in a manner other than prescribed by the manufacturer may cause its safeguards to fail!

The power supply outlet or disconnection point must be freely accessible.

The device must not be used in particular under any of the following conditions:

- The device is noticeably damaged
- The device does not function properly
- Unfastened parts can move inside the device
- The device has been exposed to moisture or rain
- The device has been serviced by unauthorized personnel
- The power adapter or power supply cable are noticeably damaged
- If the device is used in a manner other than designed for, the protection provided by the device may fail.
- The local electrical system must include a power switch or a circuit breaker and overcurrent protection.

The manufacturer warrants the device only if it is powered by the supplied power adapter or an approved power supply.

If you have any problems with installing or operating the device, please contact technical support:

HW group s.r.o.

<http://www.hw-group.com>

Email: support@HWg.cz

U Pily 3

143 00 Praha 4

Czech Republic

Tel. +420 222 511 918

When contacting technical support, please keep at hand the exact type of your device (at the type plate) and, if possible, the firmware version (see later in this manual).

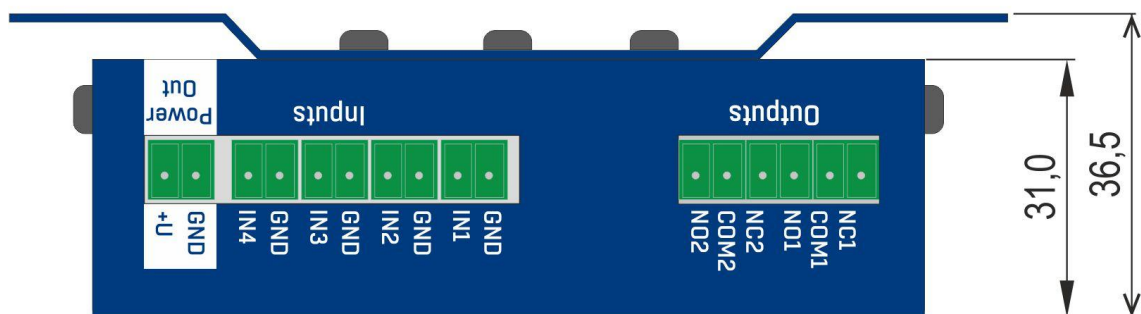
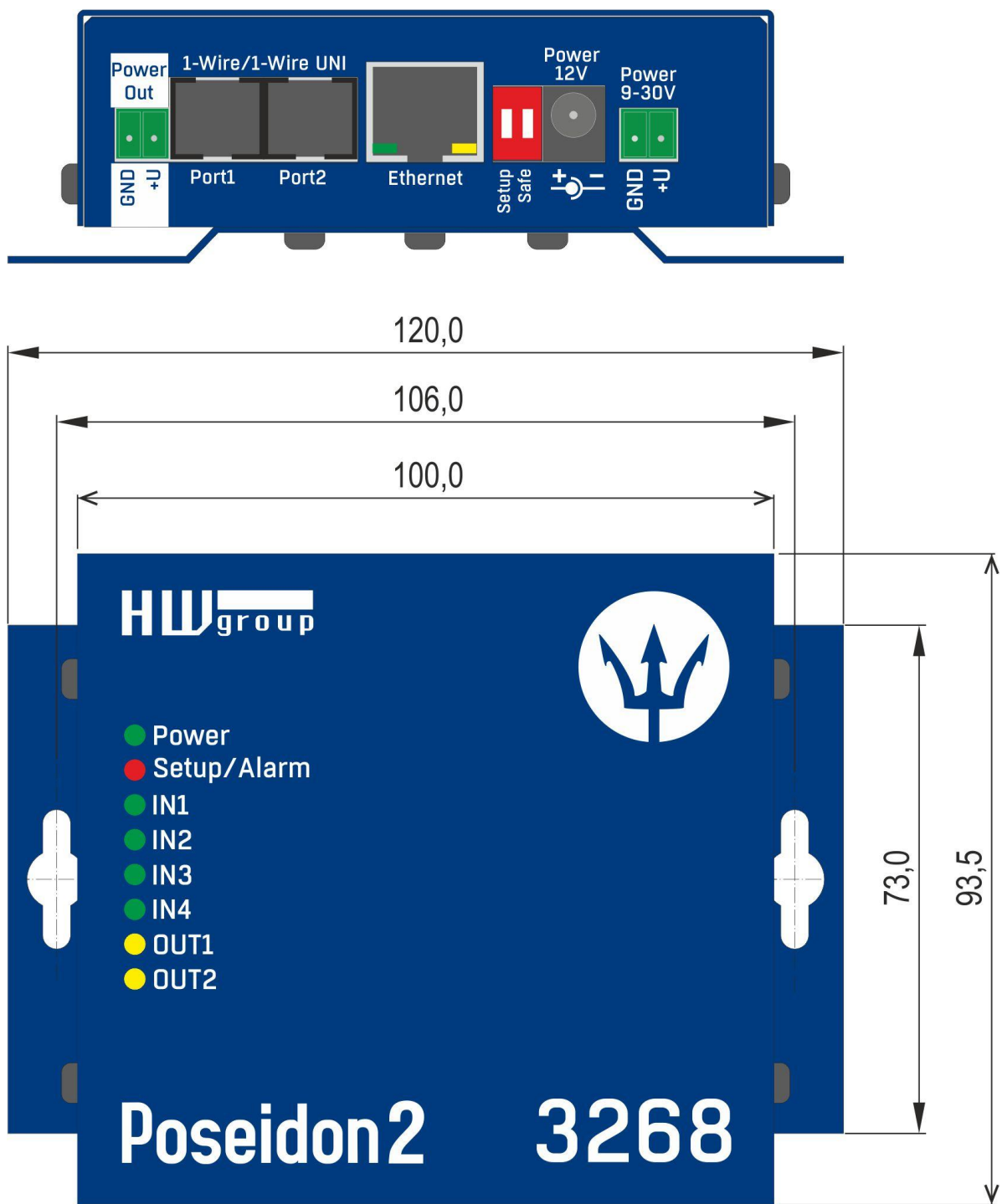

First steps

1) Connecting the cables

- Turn the unit and write down its MAC address that is printed on the label on the side.
- Set the switches: **DIP1=Off, DIP2=Off**.
- Connect the unit to the Ethernet (with a patch cable to a switch, cross-over cable to a PC), RJ-45 port.
- Plug the power adapter into a mains outlet and connect it to the Poseidon power jack.
- The green **POWER** LED lights up.
- If the Ethernet connection works properly, the **LINK** LED lights up after a short while, and then flashes whenever data are transferred (activity indication).

2) Configuring the IP address – UDP Config

UDP Config utility – root directory of the supplied CD (Windows and Linux versions). Available for download at www.HW-group.com Software > UDP Config.

- Click the icon to launch **UDP Config**. The program automatically looks for connected devices.
- Automatic device discovery works only in the local network.
- Individual Poseidon units are identified by their MAC addresses (on the label at the bottom).
- Double-click a MAC address to open a basic device configuration dialog.

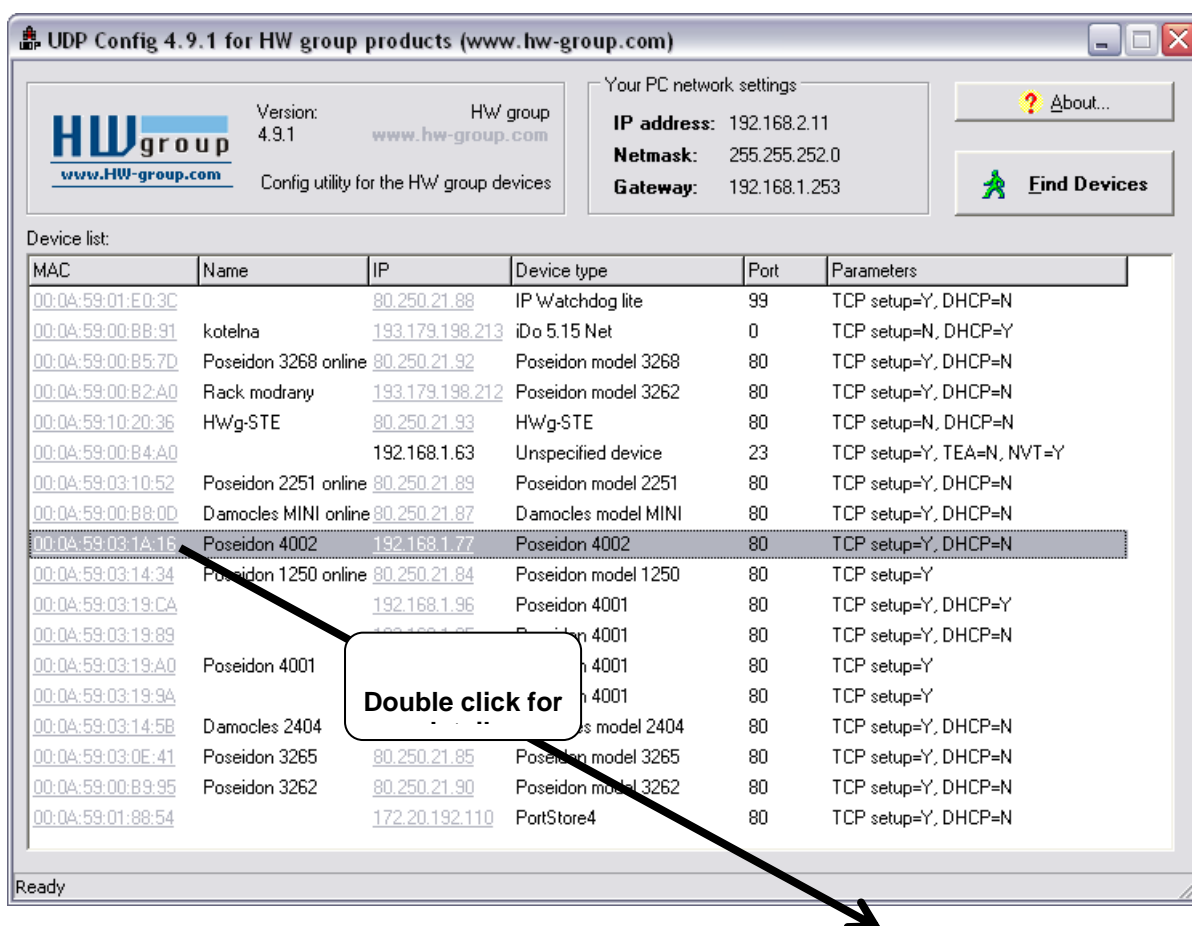

First steps

Configure the network parameters

- IP address / HTTP port (80 by default)
- Network mask
- Gateway IP address for your network
- Device name (optional)

Click the **Apply Changes** button to save the settings.

The screenshot shows a 'Details' configuration window for a device named 'Poseidon 4002'. The window contains the following fields and options:

- Name:** Poseidon 4002
- IP address:** 192.168.1.77
- Port:** 80
- Mask:** 255.255.252.0
- Gateway:** 192.168.1.253
- MAC:** 00:0A:59:03:1A:16
- FW version:** 2.0.4
- Device type:** Poseidon 4002 (26)
- DHCP:** Supported
- Enable DHCP:**
- Enable IP access filter:**
- IP filter value:** 0.0.0.0
- IP filter mask:** 0.0.0.0
- Enable NVT:**
- Enable TEA authorisation:**
- Enable TCP setup:** (with an 'Open' button)
- Check if new IP address is empty:**
- Default values:**
- Buttons:** 'Open in WEB Browser', 'Cancel', and 'Apply changes' (highlighted with a green arrow).

Alternatively, you may use the following utilities to configure the IP address:

- **UDP Config for Linux**

Important:

- To reset the device to factory defaults, toggle DIP1 several times within 5 seconds after applying power to the device.
- No configuration changes can be stored while DIP2=On.
To change the IP address, set DIP2=Off.

First steps

4) WWW interface of the device

- To open the WWW interface of the device:
 - Enter the IP address into a web browser
 - Click the IP address in UDP Setup

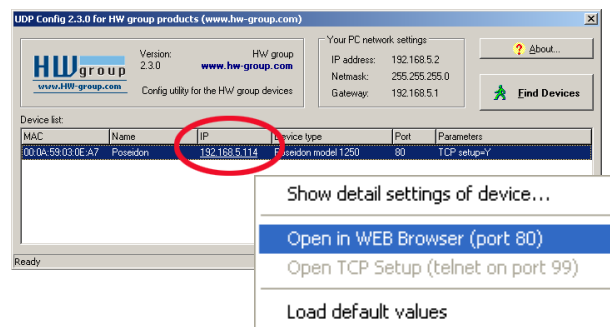

Web interface of the device

- General:** Overview of current readings
- General Setup:** IP address, DNS, security (username/password)
- SNMP:** SNMP / SNMP Trap configuration (ports and alarm recipients)
- E-mail:** Configuration and test
- GSM & RFID:** Configuration and test in order to use a remote SMS-GW
- Log & Time:** Time configuration, NTP server
- Portal:** Connection to a remote portal system
- Sensors:** Device name, sensor names, status overview
- Inputs:** Control of inputs and alert parameters
- System:** Firmware upgrade, save/restore configuration, etc.

POSEIDON2 3268 GENERAL

DRY CONTACT INPUTS

Name	ID	Current Value	Alarm Alert
Binary 1	1	0(Off)	Disabled
Binary 2	2	0(Off)	
Binary 3	3	0(Off)	
Binary 4	4	1(On)	
Comm Monitor 1	123	0(Off)	

RELAY OUTPUTS

Name	ID	Current Value	Mode
BinOut 1	151	0(Off)	Manual
	152	0(Off)	Manual

SENSORS

Name	ID	Current Value	Safe Range	Hysteresis	Alarm Alert
Sensor 240	38625	30.3 °C	10.0 .. 60.0	0.0	Disabled

DOWNLOAD

SNMP Management Information Base: [MIB](#)
 SNMP Object Identifier: [OID](#)
 XML Schema Definiton: [XSD](#)

TERMINAL CONFIGURATION (TCP SETUP)

Connect with telnet to: [192.168.2.33 Port 99](#)

For more information try <http://www.hw-group.com/>

Reload values every [s]
 Values reloaded 3

General Setup

POSEIDON2 3268 NETWORK

DEVICE
Name:

OTHER SETTINGS AND INFORMATIONS
Display temperature in:
HW Security Protection:

NETWORK SETTINGS
IP Address:
Submask:
Gateway:
Primary DNS:
Secondary DNS:
HTTP Port:
TCP Telnet Setup:
DHCP Client:

IP ACCESS FILTER

Access to	IP Address Value	IP Mask Range
HTTP	0.0.0.0	0.0.0.0
SNMP	0.0.0.0	0.0.0.0

USER PASSWORDS

	User Name	Password
Read Only:	<input type="text"/>	<input type="text"/>
Read Only + Outputs:	<input type="text"/>	<input type="text"/>
Read and Write:	<input type="text"/>	<input type="text"/>

SNMP

POSEIDON2 3268 NETWORK AND TIME

GENERAL SNMP SETTINGS
SNMP Port:

SNMP ACCESS

Community	Read	Write	Enable
public	<input checked="" type="checkbox"/>	<input type="checkbox"/>	<input checked="" type="checkbox"/>
private	<input checked="" type="checkbox"/>	<input checked="" type="checkbox"/>	<input checked="" type="checkbox"/>

SNMP TRAP DESTINATIONS

Destination	Community	IP Address	Port	Enable
A.	public	192.168.1.242	163	<input checked="" type="checkbox"/>
B.	<input type="text"/>	<input type="text"/>	<input type="text"/>	<input type="checkbox"/>
C.	<input type="text"/>	<input type="text"/>	<input type="text"/>	<input type="checkbox"/>
D.	<input type="text"/>	<input type="text"/>	<input type="text"/>	<input type="checkbox"/>
E.	<input type="text"/>	<input type="text"/>	<input type="text"/>	<input type="checkbox"/>

MIB II SYSTEM GROUP
SysContact:
SysName:
SysLocation:

E-mail

POSEIDON2 3268 EMAIL

EMAIL SETTINGS

SMTP Server: [IP Address or DNS Name]
 SMTP port:
 Email Sender Address:
 Authentication:
 Name/Password: /
 Email Subject Text:

EMAIL DESTINATIONS

Alarm Email Recipient:
 Alarm Email Copy:
 Alarm Email Copy:
 Alarm Email Copy:
 Alarm Email Copy:
 Periodic Log Recipient:

TEST EMAIL

State: no reply from SMTP

PERIODIC STATUS SETTINGS

Periodical Status: Period: [minutes]
 Alarm reminder: Period: [minutes]

Inserts the specified text at the beginning of the e-mail subject line

Sends a test e-mail and shows the connection log

Periodic Status Settings

- **Periodical Status**
When on, sends an e-mail with device status at the specified intervals. For example every 24 hours (1440 minutes).
- **Alarm reminder**
When active, sends periodic reminders that the device is in the Alarm state. For example every 15 minutes.

To send e-mail, check:

- 1) Correct **Gateway IP** address
- 2) **DNS server** in network settings
- 3) **SMTP server** and port
- 4) **Authentication** turned on, correct **username** and **password**
- 5) **Spam filter** for your mailbox is disabled

NOTE: Configuration changes must be confirmed by clicking the *Apply Changes* button.

GSM

POSEIDON2 3268 GSM AND RFID

SERIAL PORT SETTINGS Port Function: Disabled

RFID SETTINGS Remote Destination: Remote Server A

SOAP DESTINATION

	SOAP Server IP Address or DNS Name	Link /Path	Port	Enable
A.	192.168.1.36	service.xml	80	<input checked="" type="checkbox"/>

GSM SMS INTERFACE

GSM Function: Remote
SMS + Ring When Alarm:
Remote Destination: Remote Server A

GSM SMS RECIPIENTS

Alarm SMS Recipient 1:
Alarm SMS Recipient 2:
Alarm SMS Recipient 3:
Alarm SMS Recipient 4:
Alarm SMS Recipient 5:

Send Test SMS

Apply Changes

IP address of "HWg-SMS-GW" to use for sending text messages (SMS)

Recipients' phone no's

Log & Time

POSEIDON2 3268 LOG AND TIME

DATE AND TIME

Current Date: 01.11.2013 [dd.mm.yyyy]
Current Time: 08:32:18 [24 hour format]

TIME SYNCHRONIZATION

SNTP Server: time.nist.gov [IP Address or DNS Name]
Time shift to server time (GMT): +1hour [If you are in different zone]

Synchronize Time

DEVICE LOGGER SETTINGS

Store all actual sensor values to the logfile every 300 [s]
Total estimated logfile capacity is 211 days, 0 hours and 10 minutes
Report Log Period [h] 1 Erase log after e-mail

Open log File Clear log File

Apply Changes

Press to synchronize the time with the specified server

Portal

POSEIDON2 3268 PORTAL

PORTAL MESSAGE
[SensDesk.com: Check sensor online.](#) ← Message from the portal

PORTAL
 Portal Enable: ← Enable connection to the remote portal
 Push Period: 900 [s] 0=Disable
 Server Address: www.sensdesk.com/portal.php
 IP Port: 80 Default 80
 User Name: vitolmr
 Password: qehgLs
 Current Push Timer: 743
 Current Log Timer: 143
 Current Autopush Block Timer: 0
 Manual Push: ← Click to connect to the portal

SENSORS AUTO PUSH CONFIG

Name	ID	Current Value	Autopush
Sensor 240	38625	30.3 °C	0.0

DRY CONTACT INPUTS AUTO PUSH CONFIG

Name	ID	Current Value	Autopush
Binary 1	1	0(Off)	<input type="checkbox"/>
Binary 2	2	0(Off)	<input type="checkbox"/>
Binary 3	3	0(Off)	<input type="checkbox"/>
Binary 4	4	1(On)	<input type="checkbox"/>
Comm Monitor 1	123	0(Off)	<input type="checkbox"/>

AutoPush configuration

Configures the communication with the portal using the HWg-Push protocol. Poseidon2 is the active side and establishes the connection periodically and/or whenever a change in a sensor value exceeds the configured AutoPush value.

The www.SensDesk.com portal connection parameters are pre-filled.

AutoPush configuration

Poseidon2 connects to the portal and notifies a value change whenever a change in the sensor reading exceeds the configured AutoPush value.

This configuration only applies to the communication between Poseidon2 and the online portal. Local alarm values are configured in the portal.

For portal connection, check:

- 1) Correct **Gateway IP** address
- 2) **DNS server** in network settings
- 3) Correct **Server Address** of the portal

Sensors

POSEIDON2 3268 SENSORS

Configuration: Autodetect Sensors

Name	Sensor ID	Current Value	Safe Range	Hysteresis Idle Range	Delay [s]	Out of Safe Range SNMP Trap	Out of Safe Range Email & SMS
Sensor 240	38625	30.3 °C	10.0 .. 60.0	0.0	0	<input checked="" type="checkbox"/>	<input checked="" type="checkbox"/>

Apply Changes

After connecting sensors or changing RJ11 connections, sensors need to be detected again.

To avoid numerous false alerts (by e-mail or SMS) whenever the reading fluctuates around the threshold, you can use:

- 1) **Hysteresis Idle Range**
Tolerance band around the "Safe Range". Prevents multiple alarm alerts.
- 2) **Delay [s]**
Delays the information about alarm beginning and alarm end by a specified time. Can be used for dry contacts, too.

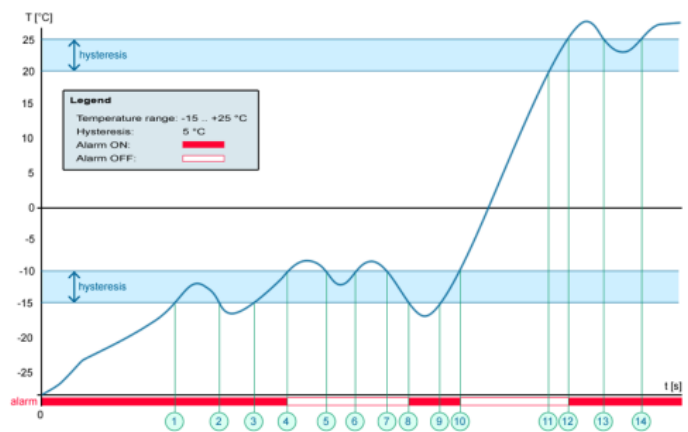

Tip: For details, see the complete "Poseidon family" manual.

NOTE: Configuration changes must be confirmed by clicking the Apply Changes button.

Inputs



POSEIDON2 3268

INPUTS

- General
- General setup
- SNMP
- Email
- GSM & RFID
- Log & Time
- Portal
- Sensors
- Inputs
- Outputs
- System
- Restart

DRY CONTACT INPUTS

Name	ID	Current Value	Alarm State	Delay[s]	Out of Safe Range SNMP Trap	Out of Safe Range Email & SMS
Binary 1	1	0(Off)	Active if on	0	<input type="checkbox"/>	<input checked="" type="checkbox"/>
Binary 2	2	0(Off)	Active if off	0	<input checked="" type="checkbox"/>	<input checked="" type="checkbox"/>
Binary 3	3	0(Off)	Disabled	0	<input type="checkbox"/>	<input type="checkbox"/>
Binary 4	4	1(On)	Disabled	0	<input type="checkbox"/>	<input type="checkbox"/>
Comm Monitor 1	123	0(Off)	Disabled	0	<input type="checkbox"/>	<input type="checkbox"/>

Enter Digital Input name, will be shown in e-mails, text messages or SNMP traps

ALARM CONTACT STATUS:

- Active if On**
Alarm when the contact closes (1 = On)
- Active if Off**
Alarm when the contact opens (0 = Off)
- Disabled**
No Alarm

Reaction to digital inputs:

- Disabled
- Send a **SNMP Trap**
- Send an **E-mail**
- Send a **SMS**

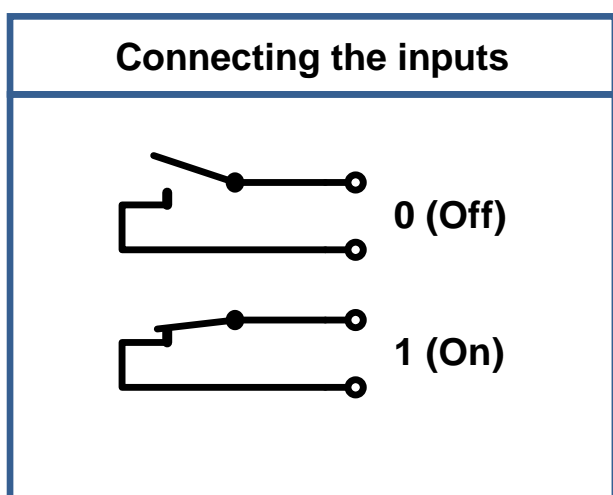

- ### FAQ
- Poseidon2 informs about alarm activation and deactivation for each Digital Input and/or sensor.
 - E-mail format cannot be changed; sensors may have custom names.
 - Yellow background in a line with a sensor or an input means that the safe range is exceeded but alarm notification is off.

NOTE: Configuration changes must be confirmed by clicking the *Apply Changes* button.

TIP

- Poseidon family manual**
For a detailed description of all settings and tabs in the configuration interface, see the “Poseidon Family” manual. Available on the WEB or on the install CD.

Outputs

POSEIDON2 3268 OUTPUTS

RELAY OUTPUTS

Choose the **output mode**

Name	ID	Current Value	Output Control	Target Value	Depend on
BinOut1	151	0(Off)	<input checked="" type="radio"/> Manual <input type="radio"/> Local Condition	28	Sensor 240(38625)
BinOut2	152	0(Off)	<input checked="" type="radio"/> Manual <input type="radio"/> Local Condition	0.0	none

Manual mode:
Output controlled over the WEB or M2M protocols

Local Condition mode:
Controls the output according to the specified sensor

Apply Changes

Output mode:

A) **Manual**

Output can be controlled using the Web interface or externally using M2M protocols. The output cannot be used in “thermostat” mode – local condition.

B) **Local Condition**

The output cannot be controlled using the Web interface, it is controlled by the local condition. The output is read-only for all M2M protocols. Hysteresis configured in the sensor settings applies.

The output cannot be controlled remotely.

- **On if any alarm**
The output is active if at least one input or sensor is in alarm.
- **On if value equal to Trigger**
The output is active if the selected sensor reading **is equal to** the “Target Value”.
- **On if value higher than Trigger**
The output is active if the selected sensor reading **is greater than** the “Target Value”.
- **On if value lower than Trigger**
The output is active if the selected sensor reading **is less than** the “Target Value”.
- **Dependent On** – sensor / input to which the condition applies.

System

Communication Monitor

This function controls a virtual Digital Input that is available in **Inputs** as “Com Monitor 1” with an ID of 123. If no communication took place in the specified time using the selected protocols, it sets “Com Monitor 1” = 0 (Off).

This function is useful e.g. to send a warning e-mail whenever Poseidon2 ceases to be periodically monitored over SNMP or SCADA.

Configuration

- Download – retrieve the configuration from the device and store it on the PC.
- Upload – send a saved configuration from the PC to the device.

NOTE: Configuration changes must be confirmed by clicking the *Apply Changes* button.

Software Applications

HWg-PDMS

Windows application that logs data from all HW group devices into its internal database.

The application runs in the background (NTservice). Data are received from the device over http or e-mail.

Data can be exported over XML or automatically stored to MS Excel.

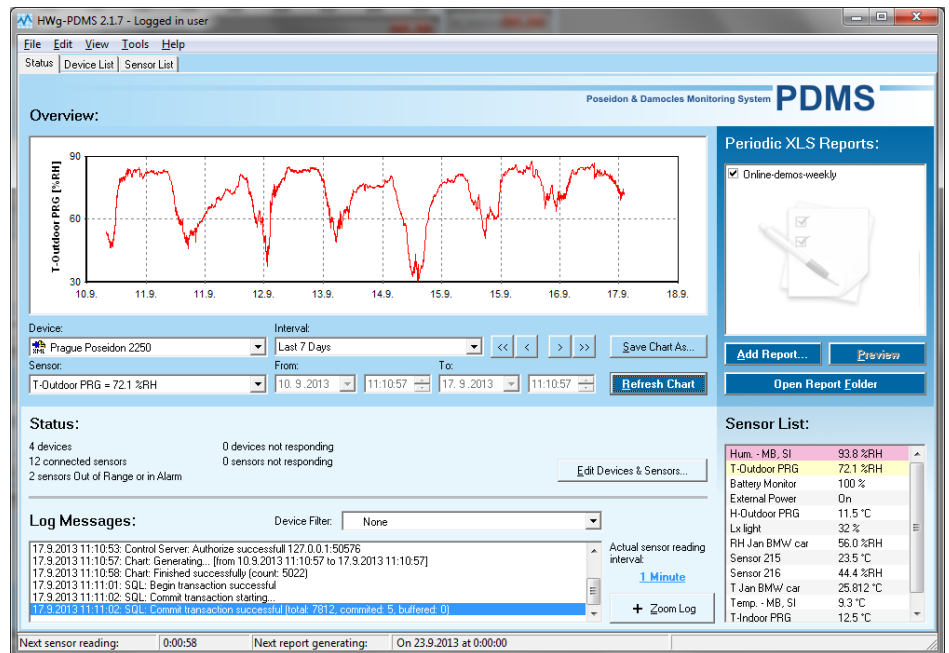

License: Free HWg-PDMS version for 3 sensors
Paid versions for 8 / 20 / 200 / unlimited sensors

HWg-Trigger

Windows application for detecting and reacting to events.

Detects, for instance, disconnected devices, failed sensors values out of range, or incoming SNMP Trap alerts.

Possible responses include sending an e-mail, activating a relay over the network, or sending a text message (SMS) using HWg-SMS-GW.

Other responses include displaying a warning message in Windows, starting an application, or shutting down the computer.

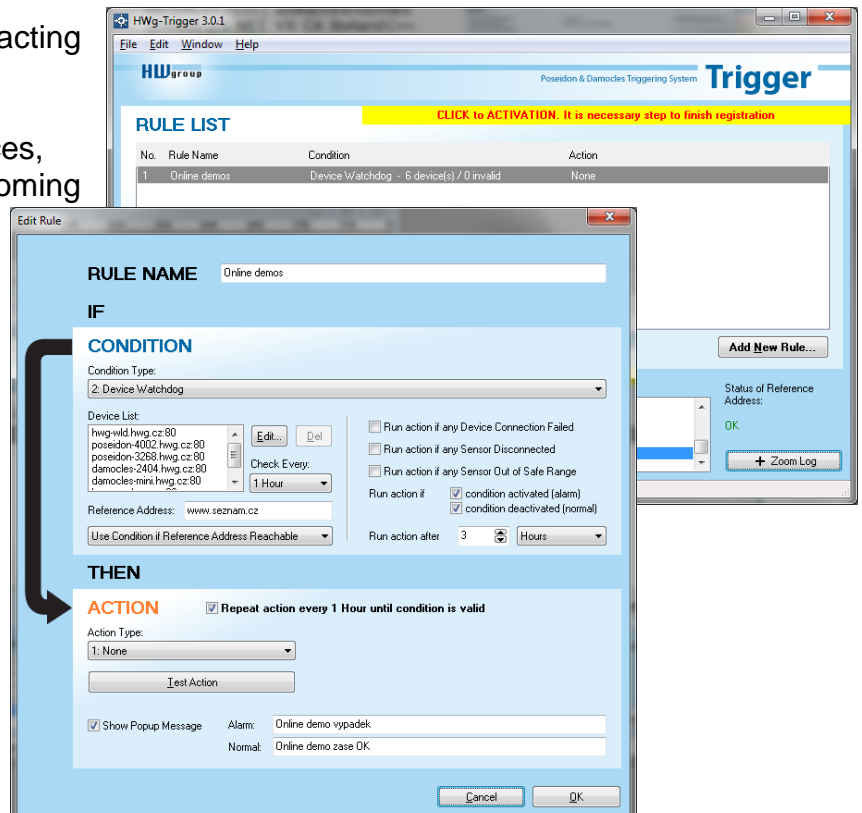

License: 30-day trial version free of charge

PosDamIO

Poseidon Damocles I/O is a command-line utility for Windows and Linux that lets you control Poseidon and Damocles units over the XML interface. It can display the states of sensors, inputs and outputs, as well as set an output high or low.

```

C:\Program Files\Poseidon2\bin>posdamio
Poseidon2 3268 (ID: 35)
Name: HWg-STE Push Jan Office
Type: HWg-STE Push Jan Office
Firmware: 1.0.0
IP: 192.168.1.100
Port: 8080
Status: Online
Sensors:
  Name          Unit          Value
  ---          ---          ---
  Office STE ind. test  °C          23.7
  Office STE Outdoor   °C          18.3
Inputs:
  Name          State
  ---          ---
  Input 1       OFF
  Input 2       OFF
Outputs:
  Name          State
  ---          ---
  Output 1      OFF
  Output 2      OFF
  
```

SensDesk.com

Online portal for collecting data from LAN and GSM sensors.

Poseidon2 can connect to the SensDesk internet service. All devices can be managed from a single WWW interface. Watch sensor states, display your devices in a map, compare trends in time and analyze alarm messages.

SensDesk is a way to implement fully functional monitoring of customer technology in a matter of minutes, with fixed costs of the system. No need for installing a complex system or adding another server at the customer side.

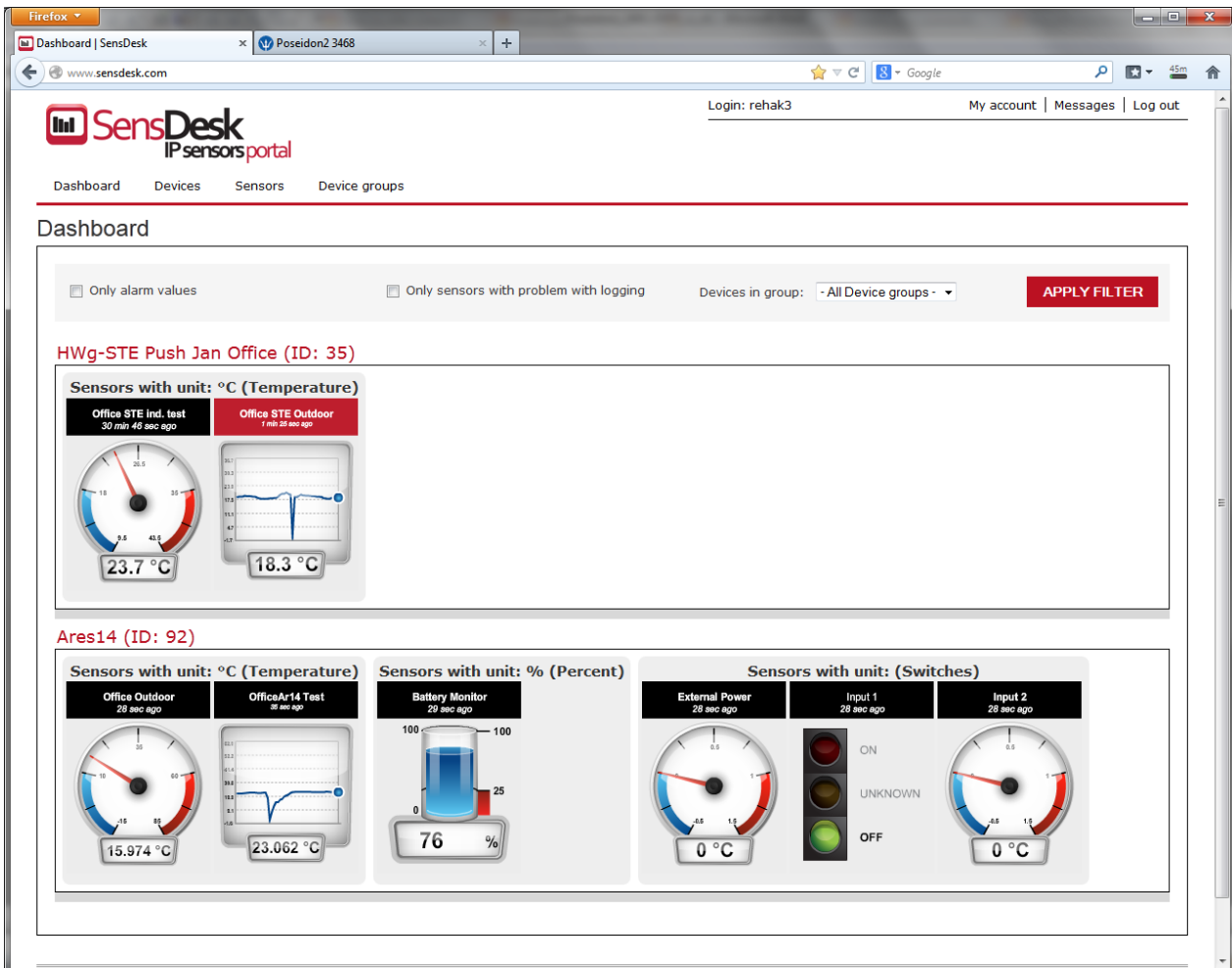

- Overview of all sensors at a single place
- Centralized alarm configuration for individual sensors
- Mobile application for monitoring
- Remote configuration of GSM devices.

www.SensDesk.com

Specifications

ETHERNET	
Interface	RJ45 (100BASE-Tx) – 10/100 Mbps network compatible
Supported protocols	IP: ARP, TCP/IP (HTTP, NTP, SMTP, netGSM, HWg-PUSH), UDP/IP (SNMP)
SNMP compatibility	Ver.1.00 compatible, partial ver.2.0 implementation
Logger	
Internal memory	250,000 records in flash memory
Logged items	Sensors, DI, DO
SENSORS	
Type	HWg original accessories: 1-Wire & 1-Wire UNI
Connector	2xRJ11
Sensors	Up to 8 sensors in total (temperature + humidity combo sensors count as 2 sensors)
Sensor distance	Up to 60m
DI (Digital Inputs for Dry Contacts)	
Port	I1, I2, I3, I4
Type	Digital Input (supports NO/NC Dry contact)
Sensitivity	1 (On) = 0–500 Ω
Max. distance	Up to 50m
OUTPUTS	
Port / type	OUT1, OUT2 / Relay contacts (NC-COM-NO)
Max. voltage	60V AC/DC
Max. load	Max 1A, up to 60VA/24W (0.5A/48V)
State	Power up state (no state restart memory)
POWER input	
Port	POWER 9-30V DC
Power input	9-30V DC / 2,5W (typically 250 mA) Connectors: Jack (barrel, inner 2.5 mm outer 6.3 mm) + Terminal Block
POWER output	
Voltage	Power Out = Power IN (9–30V)
Current / Connector	Max. 150mA / Terminal Block
LED status indicators	
POWER (RJ45 + top)	Green – power OK (top), Ethernet enabled (RJ45)
LINK & Activity (RJ45)	Yellow - Ethernet connectivity
Setup / Alarm	Red
Inputs	Green
Outputs	Yellow
DIP SWITCH	
DIP1: Setup	OFF = Normal state Load defaults: Set ON, power-up device, toggle 3 times during first 5 seconds
DIP2: Security	ON = Secure mode (online demo) – remote configuration disabled OFF = Non-secure mode – remote configuration enabled
Physical parameters	
Temperature range	Operating: -30 to +85 °C (-22 to 167 °F) / Storage: -35 to +85 °C (-31 to +185 °F)
Dimensions / Mass	145 x 90 x 45 [mm] / 225 g
EMC	FCC Part 15, Class B, CE - EN 55022, EN 55024, EN 61000

Power output

Poseidon2 3268 features the PWR OUT terminals for powering connected sensors and detectors. For example a smoke detector.

PWR OUT voltage corresponds to the Poseidon 3268 supply voltage!

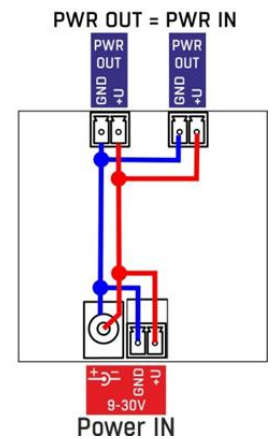

Relay outputs

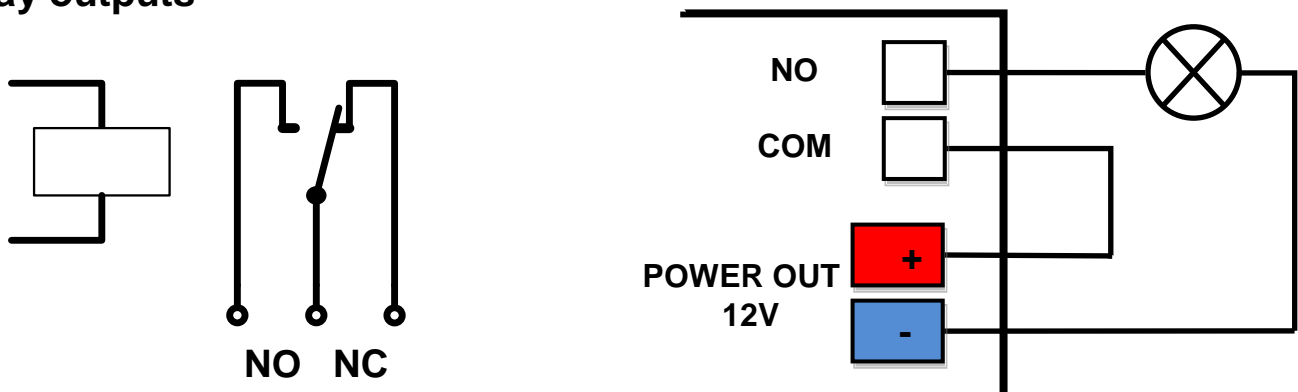

- NO and NC labels apply to Off (0) state, or device turned off
- When the output is On (1), a “**Normally Open**” (NO) relay contact is closed
- **LEDs:** Contact state (closed / open) is indicated by a LED
- **Isolation:** The double-throw contact is electrically isolated from the rest of the device
- **ID range:** Outputs use ID addresses from 151 to 180

Inputs – Digital (dry contact) inputs

Digital input terminals may be connected to voltage-free contacts or the GND pin. The inputs are electrically connected to the 12V power supply. Never connect the inputs to the 48V supply voltage!

- Unconnected inputs read as “**0 (Off)**”
- Active inputs read as “**1 (On)**”
- **Supported sensors:** Any contact without external voltage (dry contact)
- **Polling period:** 800 ms
- **Range of sensor IDs:** Inputs use IDs from 1 to 24

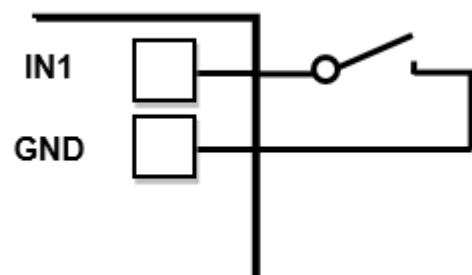

M2M interface

The product is ready to be connected with third-party SW applications.

For a description of the interfaces (XML format, detailed SNMP description, mapping of Modbus/TCP variables), see the detailed “**Poseidon family**” manual.

- **XML** (over HTTP)
- **SNMP** , SNMP traps
- **Modbus/TCP**
- **SMTP** (E-mail)

TIP

- For a detailed description of the M2M communication interface and other details, see the **detailed Poseidon family manual**.

SDK (Software Development Kit)

Programmers can take advantage of the **HWg SDK** (Software Development Kit) with an ActiveX interface and ready-made examples.

- **VB - Visual Basic (6.0)** - (3xx examples)
- **Borland C++** (1xx examples)
- **Microsoft Visual C++** (2xx examples)
- **C# / .NET** (5xx examples)
- **Borland Delphi** (4xx examples)
- **JAVA**
- **PHP / ASP**
- **other** examples that do not directly use SDK functions (all 9xx examples)

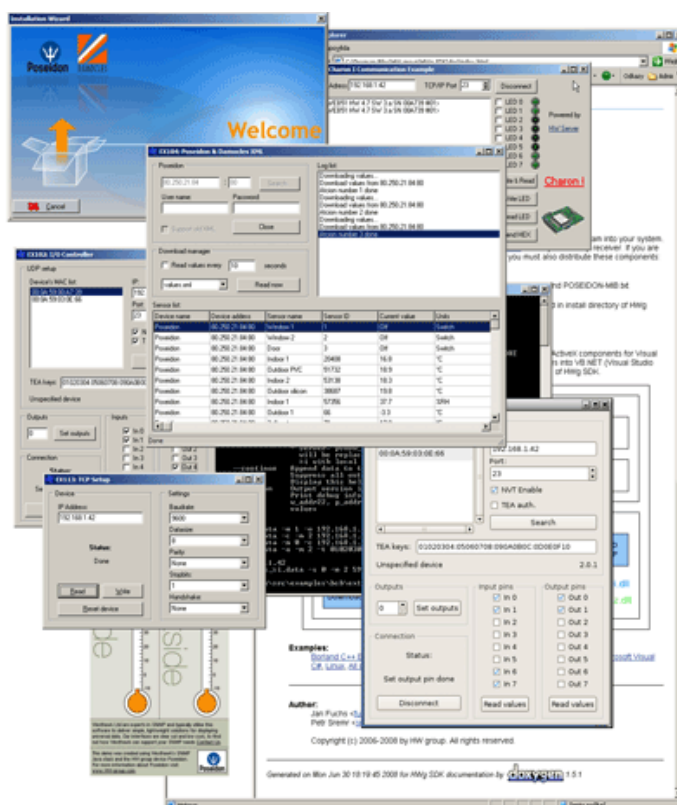

Note: *The latest version of HWg-SDK is available for download at the HWg website. You just need to register your e-mail.*

Updating the firmware over the WEB

Upload the **.hwg** firmware file over http to <http://x.x.x.x/upload/>.
Connection problems must be avoided during file transfer.

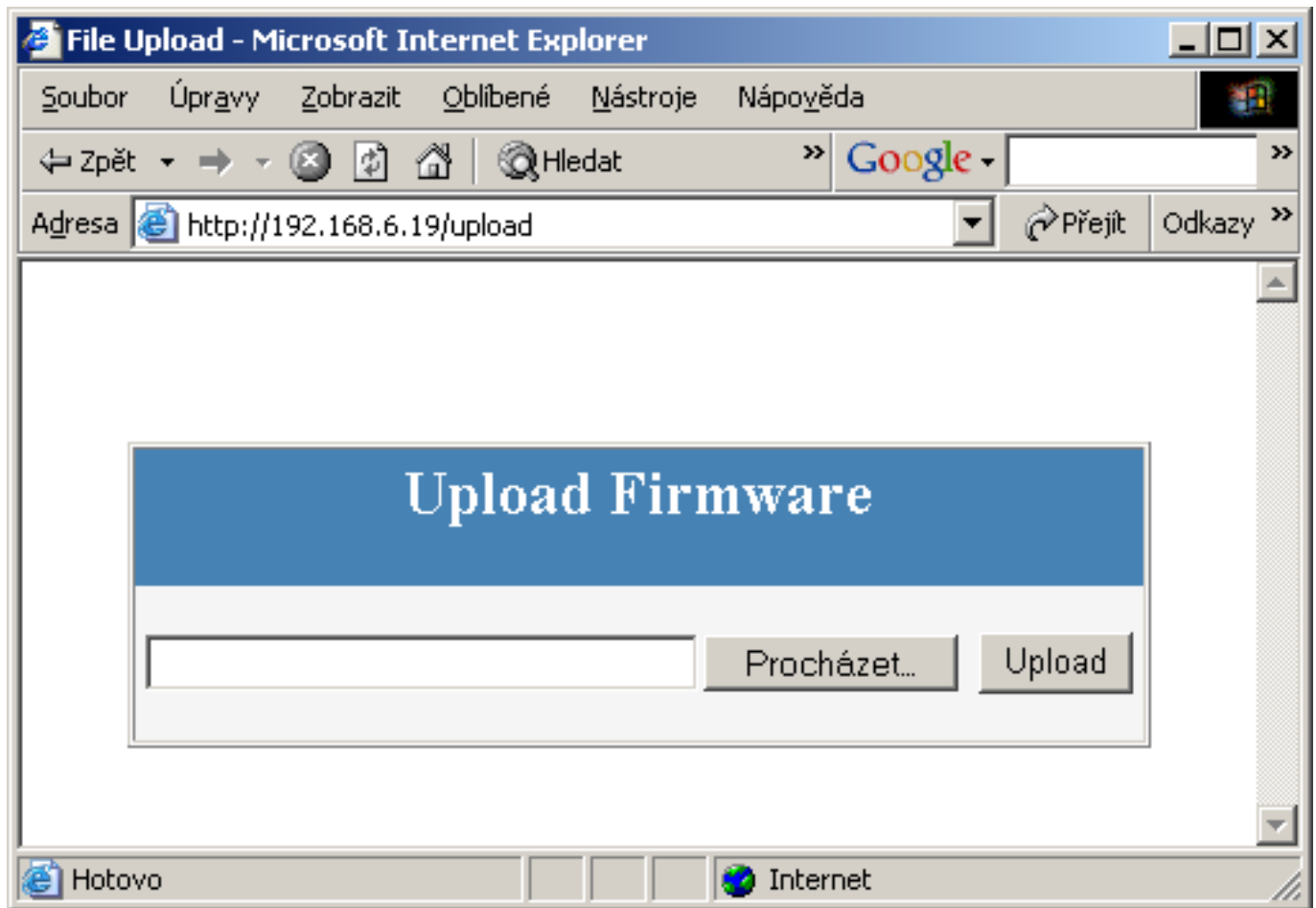

Firmware in the .HWg format is available at our website, or on the supplied CD.

Restoring factory defaults

To restore the factory default configuration (including deleting all passwords):

- 1) Turn the device off by disconnecting power.
- 2) Set DIP1 to ON.
- 3) Turn the device on.
- 4) Toggle DIP1 several times during the first 5 seconds after powering up.

TIP

- For a detailed product description, see the **detailed Poseidon family manual**.

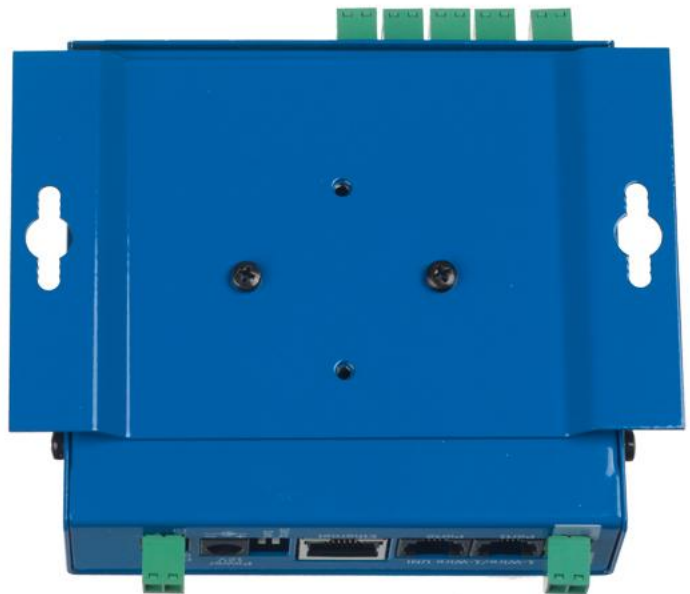
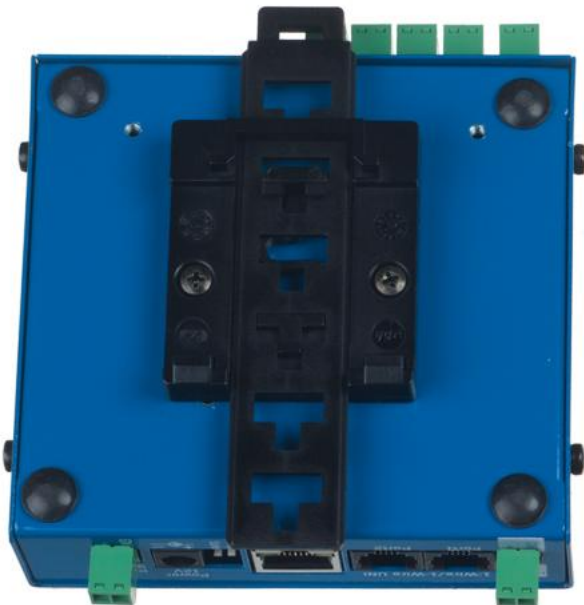

Contact

HW group s.r.o

Rumunská 26 / 122
Praha 2, 120 00, Czech republic

Tel. +420 222 511 918

Fax. +420 222 513 833



<http://www.HW-group.com>